

Stanzformen für Cover Form

1

Umschlagtitelseiten (in Originalgröße)
für formgestanzte Haftnotizen (aus 100 x 72 mm) mit 50 Blatt

Stand: 04-2024

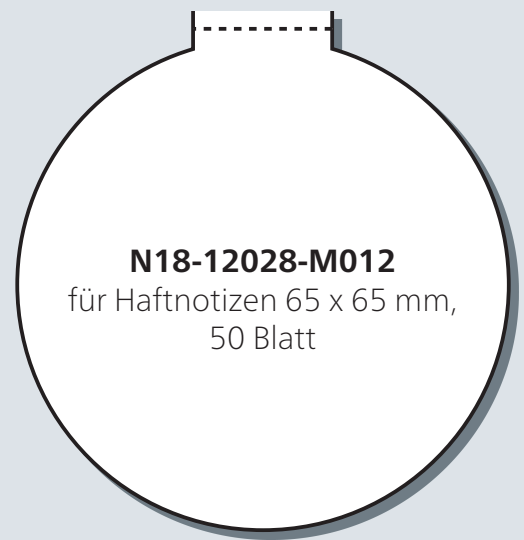
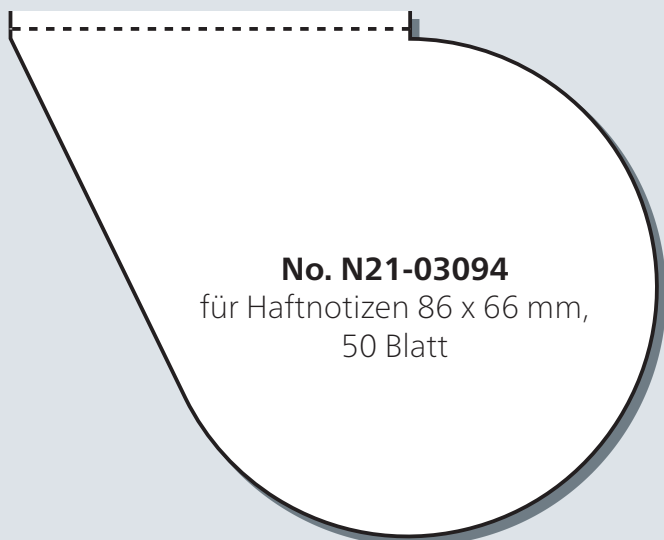
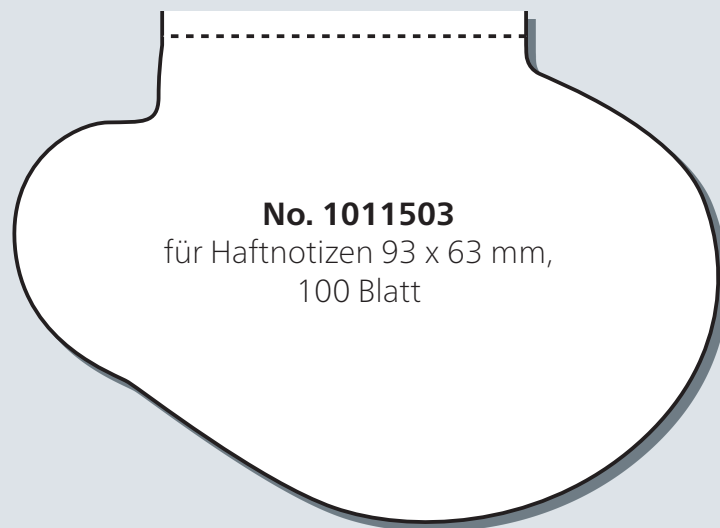
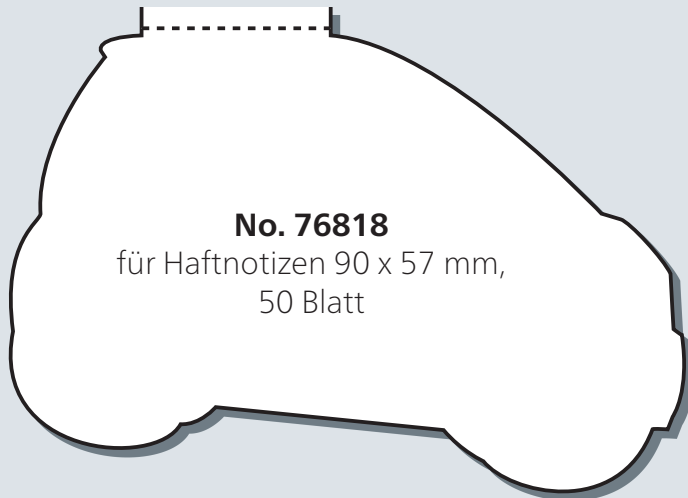

Stanzformen für Cover Form

2

Umschlagtitelseiten (in Originalgröße)
für formgestanzte Haftnotizen (aus 100 x 72 mm) mit 50 Blatt

Stand: 04-2024

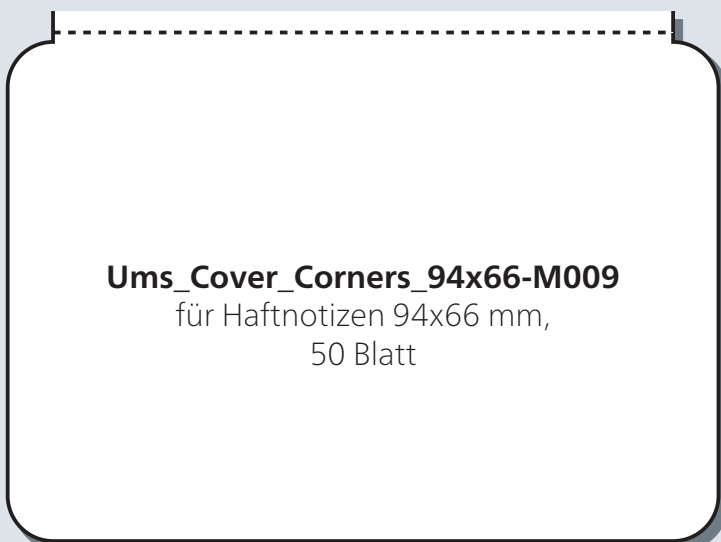
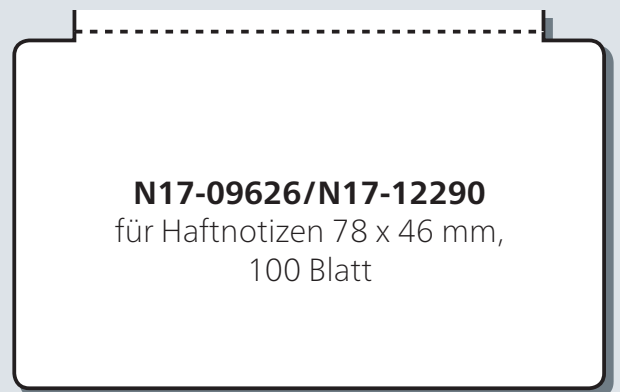
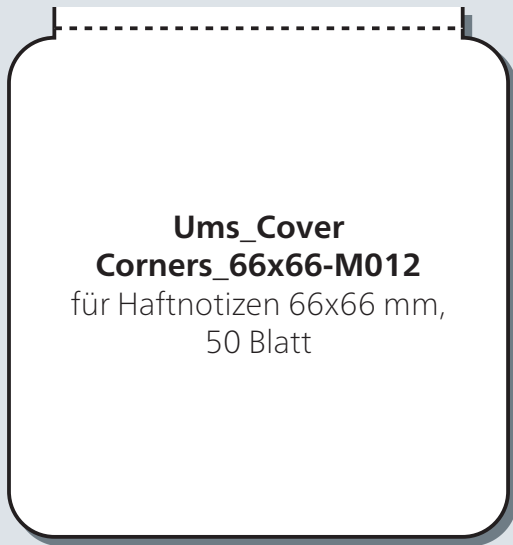

Stanzformen für Cover Form

3

Umschlagtitelseiten (in Originalgröße)
Sonderausführungen lt. Beschreibung

Stand: 04-2024

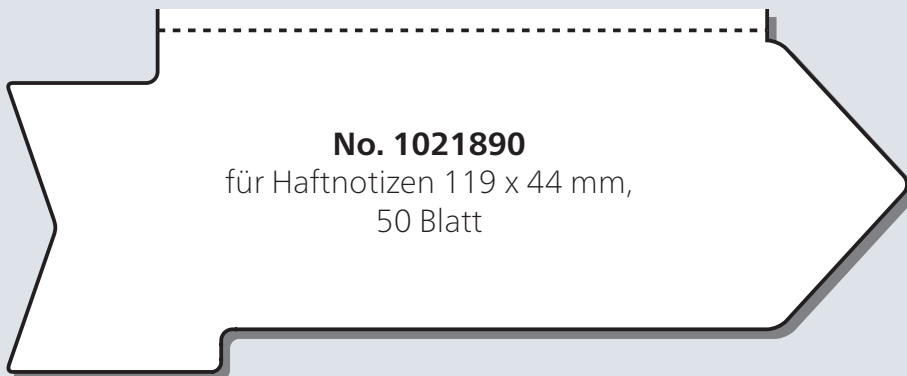
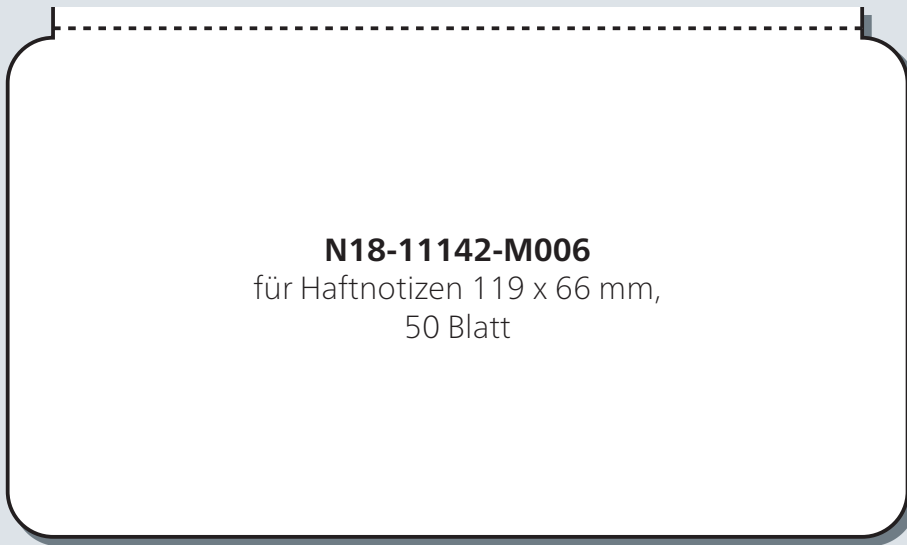

Stanzformen für Cover Form

4

Umschlagtitelseiten (in Originalgröße)
Sonderausführungen lt. Beschreibung

Stand: 04-2024

